

SC-8100 Note Counter

User's Guide



Contents

General Information	1
Declaration of Conformity	1
Environmental Compliance	1
WEEE Directive (valid in the EU only)	1
Responsibility	1
Safety Precautions	2
Introduction	3
Software Version	3
Accessories and Options	3
Machine Part Terminology	3
Front view	3
Rear view	4
Positional References	4
Control Panel	4
LCD Screen	5
Currency mode	5
Detection off mode	5
SET menu	5
Settings menu	5
Advanced Setting	5
Installation	6
Installing and Removing Note Guides	6
Machine Label	6

Modes of Operation	7
Counting Modes	7
Operation	7
Getting Started	7
Switching Off	7
Inserting Banknotes	8
Functions	8
LCD Screen	9
Print a Receipt	9
Counting	9
Settings in the SET Menu	9
Counting Speed	9
Settings	9
Add	9
Auto Start On/Off	10
Detection Off Mode	10
UV detection	10
Size detection	10
MG detection	10
Double detection	11
Batch Counting	11
Adjustments	11
Contrast	11
Back Light	12
Sounds	12
Alarm	12

Key Beep	12
Exchange Table	12
Advanced Setting.	13
Switch On mode	13
Print Paper.	13
Print BPS.	13
Stacker Full Quantity.	14
List Mode Order	14
Sort Mode	14
Batch Add Mode	15
Device Information	15
Thickness Setting.	15
Troubleshooting	16
Maintenance	17
Cleaning	17
SD Update	17
Technical Data.	18

General Information

SUZOHAPP reserves the right to revise and improve its products as it sees fit. This publication describes this product at the time of publication and may not reflect the product in the future.

This publication, or parts thereof, may not be reproduced in any form whatsoever other than for the purchaser's personal use without the express permission of SUZOHAPP.

Declaration of Conformity

We, SUZOHAPP, declare under our sole responsibility, that the product in this manual, is in conformity with the following standards and/or other normative documents:

- EN 60 950-1:2006/A11:2009/A1:2010/A12:2011;
- EN 61 000-3-2:2006/A1:2009/A2:2009;
- EN 61 000-3-3:2008;
- EN 55 022:2010;
- EN 55 024:2010;

following the provisions of:

- Low Voltage Directive 2006/95/EC;
- EMC Directive 2004/108/EC;
- RoHS 2 Restriction of Hazardous Substances Directive 2011/65/EU.

Environmental Compliance

WEEE Directive (valid in the EU only)

Waste Electrical and Electronic Equipment Directive 2012/19/EU.



Equipment marked with this symbol must be treated separately and in accordance with any local legislation requiring proper treatment, recovery and recycling of used electrical and electronic equipment.

Contact your SUZOHAPP representative for further details.

Responsibility

The supplier of the equipment accepts no responsibility for injury or damage to personnel or equipment if the equipment is altered in any way or used in a manner for which it was not intended at the time of delivery. If the conditions for use of the equipment are changed, the supplier must be contacted or the declaration of conformity is invalidated.

Safety Precautions

This guide contains hazard information which **must** be read by all users. The hazard information is presented as a warning as follows:



WARNING!
Risk of personal injury!

Warnings indicate a potential hazard to the health and safety of users. They clearly state the nature of the hazard and how to avoid it. The warning symbols appear at their points of application in this guide.

Caution!

Cautions indicate a hazard to the machine, but not a danger to personnel. They clearly state how to avoid the hazard. They appear at their points of application in this guide.



WARNING!
Risk of electric shock!

Lethal voltages exist in the machine when connected to mains power. Make sure you disconnect the power cord before cleaning or servicing the machine.



WARNING!
Risk of electric shock!

The machine is of metal construction and must therefore always be earthed to the supply. Ensure that both the plug on the supply lead and the supply source are earthed. This is a requirement for this type of equipment and if not adhered to will contravene the national and international standards of Health and Safety in the work place.



WARNING!
Risk of jamming!

This machine contains moving parts and sharp edges. Always be careful. Do not touch the components inside the machine while it is running.



WARNING!
Risk of entanglement!

Keep long sleeves, ties, necklaces and long hair that can trigger the autostart sensor away from the machine. If the autostart function is enabled, the machine may start.

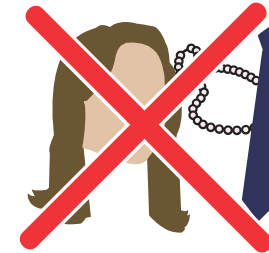

Introduction

The SC-8100 is a compact note counter, light to carry and easy to operate. The easy access to the note path and sensor area makes it simple to clean the area and to remove jammed notes.

Notes to be counted are placed on the hopper on top of the machine. As the notes are fed into the machine they are counted and then collected onto the stacker pocket at the bottom front.



Updates are done by inserting an SD card in the SD card slot at the back of the SC-8100. Machine upgrades, for example adding another currency, is done by a technician through the USB connection and a PC software. Five different currencies can be installed simultaneously.

The sensors module include:

- IR - Infrared Sensor
- MG - Magnetic Sensor
- UV - Ultra Violet Sensor

Software Version

This User's guide relates to main software version 001.108. For information about the currency version see [“Device Information” on page 15.](#)

Accessories and Options

For information about the accessories and options available for this machine, contact your SUZOHAPP representative.

Machine Part Terminology

Front view

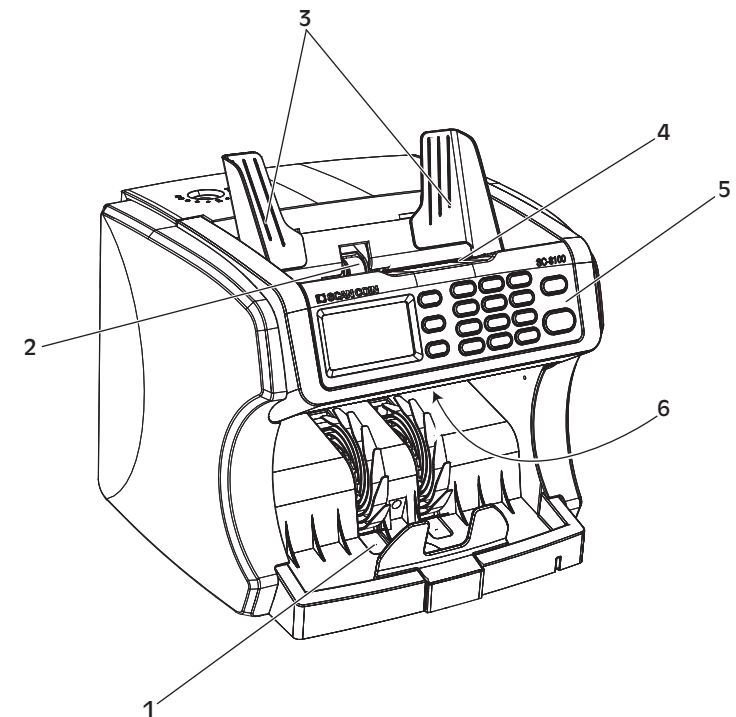

- 1 Stacker pocket
- 2 Kicker roller
- 3 Note guides
- 4 Hopper
- 5 Control panel
- 6 Carrying handle

Rear view

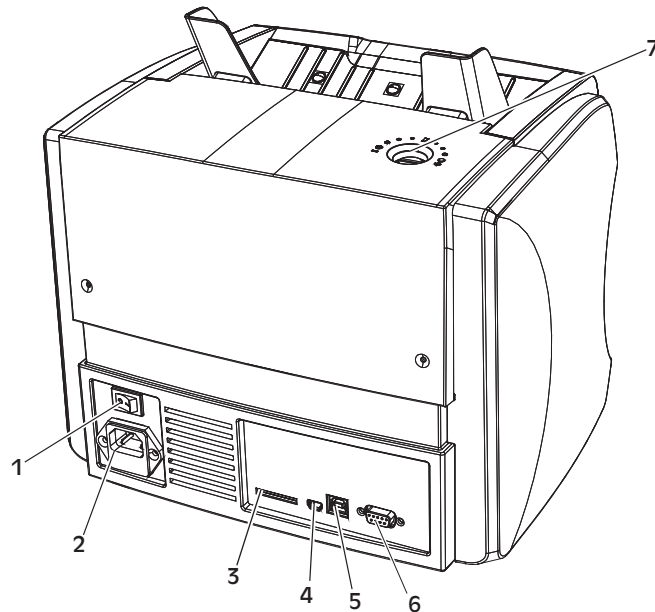

- 1 Main switch
- 2 Mains socket
- 3 SD card slot
- 4 Display port
- 5 USB device port
- 6 Serial printer port
- 7 Thickness adjustment knob

Positional References

Unless stated otherwise, positions and directions such as left, right, upper, lower, rear, clockwise and counterclockwise are given with respect to the machine when viewed from the front.

Control Panel

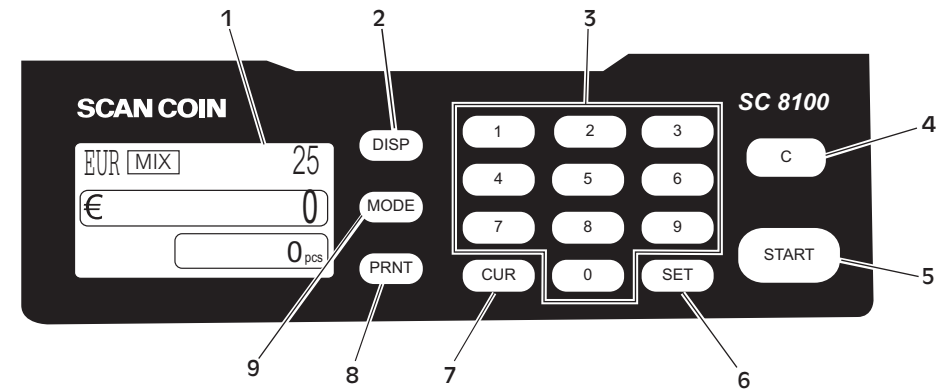

- 1 LCD screen
- 2 DISP - select screen view/left and up navigation
- 3 Number keys
- 4 Clear - revert to the previous setting/back navigation
- 5 START
- 6 SET - SET menu
- 7 CUR - select a currency or deactivate the detection
- 8 PRNT - confirm a selection
- 9 MODE - select a sorting mode/right and down navigation

LCD Screen

Currency mode

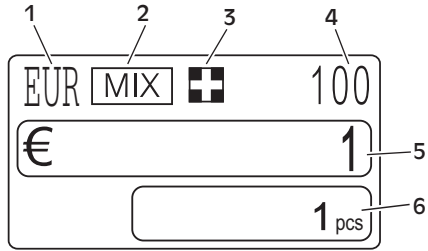

- 1 Currency
- 2 Sorting mode
- 3 Add mode
- 4 Batch
- 5 Value
- 6 Amount

Detection off mode

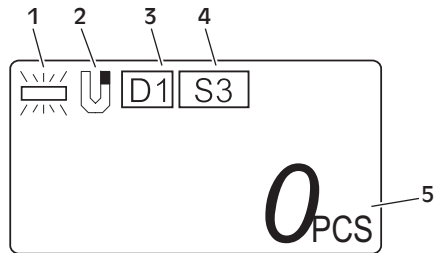

- 1 UV detection
- 2 MG detection
- 3 Double detection
- 4 Size detection
- 5 Amount

SET menu

Page 1

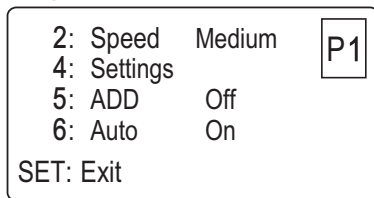

Page 2

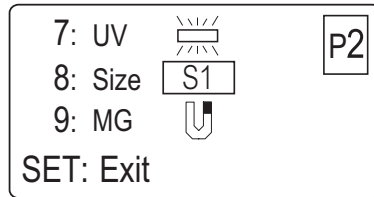

Page 2 of the SET menu is only available when the detection is deactivated - Detection Off mode. Toggle between the two pages with DISP.

Settings menu

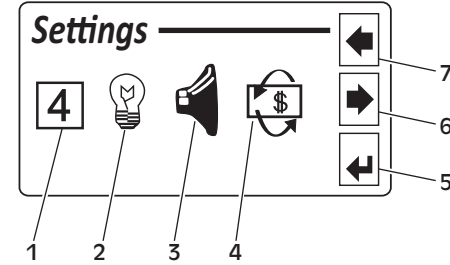

- 1 Contrast
- 2 Back light
- 3 Sounds
- 4 Exchange table
- 5 Confirm a selection
- 6 Right navigation
- 7 Left navigation

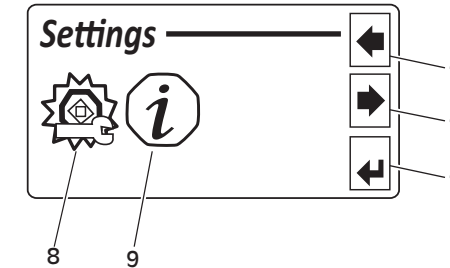

- 8 Advanced setting
- 9 Device information
- 10 Confirm a selection
- 11 Right navigation
- 12 Left navigation

Advanced Setting

Page 1

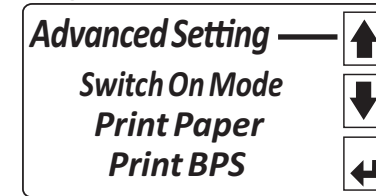

Page 2



Page 3

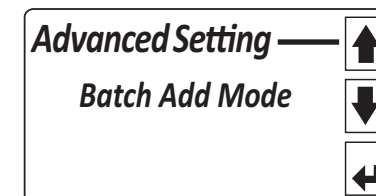

Installation



WARNING!
Risk of electric shock!
 Follow the ["Safety Precautions" on page 2.](#)

Caution!
 The machine must be protected by a fuse or circuit breaker in the electrical circuit.

The machine must be installed by an authorised SUZOHAPP representative.

Please also note the following when installing the machine:

- Operating temperature 15-35 °C
- Operating humidity 20-90% R.H. (non-condensing)

Do not place the machine close to any radiators. Make sure there is some free space around the machine to allow the air to circulate.

Place the machine in a clean environment and on a stable place.

The socket-outlet shall be installed near the equipment and shall be easily accessible.

If the plug on the supply lead to the machine has a fuse, make sure it has the correct rating in amps.

Although this machine has been tested and complies with the national and international standards/regulations, it is recommended that no equipment which generates a high level of electromagnetic interference (EMI) or vibration is placed close to the machine.

Installing and Removing Note Guides

Install and remove the note guides according to the pictures below.

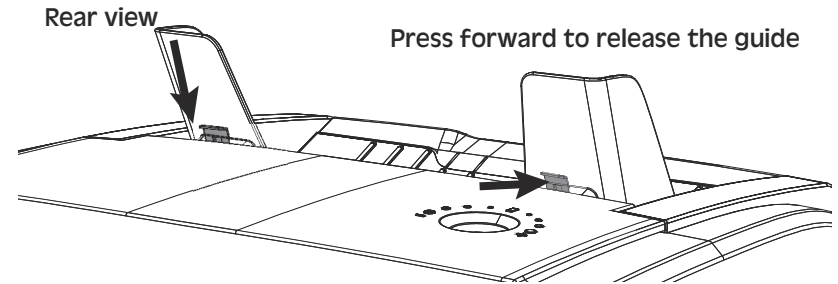

Machine Label

The label below is an example of the information available on the machine.

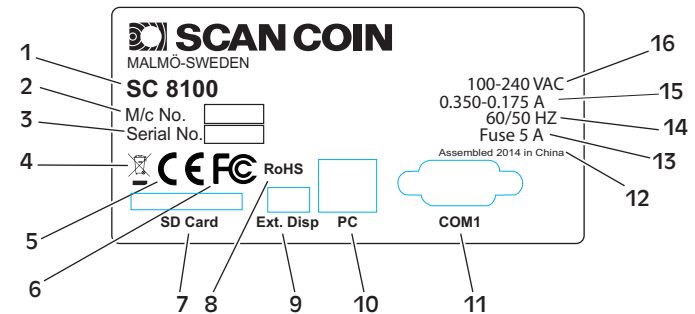

- | | |
|----------------|----------------------------------|
| 1 Machine type | 10 PC |
| 2 Machine No. | 11 COM1 |
| 3 Serial No. | 12 Year and place of manufacture |
| 4 WEEE-symbol* | 13 Fuse |
| 5 CE-symbol | 14 Frequency |
| 6 FC-symbol | 15 Current consumption |
| 7 SD Card | 16 Supply voltage |
| 8 RoHS | |
| 9 Ext. Disp | |

* See ["Environmental Compliance" on page 1.](#)

Modes of Operation

Counting Modes

- **Mixed counting**
Counts a bundle of mixed genuine banknotes of the selected currency.
- **Single counting (DD)**
Counts only the first denomination detected, all others are rejected.
- **Free counting**
Counts a number of documents using the sensors activated in the **SET** and **MODE** function.

Note!

The first banknote in a bundle is always the reference note.

Operation



WARNING!

Risk of jamming!

Follow the ["Safety Precautions" on page 2.](#)

Caution!

Do not press the buttons with sharp objects.

Getting Started

- a) Connect the mains power cord to the mains socket at the rear of the machine. See, ["Rear view" on page 4.](#)
- b) Start the machine by setting the main switch to on (I).

Note!

Images are only examples and can be different depending on the setup.

Switching Off

- a) Confirm that all counting results are saved.
- b) Switch off the machine by setting the main switch to off (0).

Inserting Banknotes

Avoid counting wet, dirty or spoiled banknotes.

- Check for foreign matter mixed with the banknotes for example paper chips, rubber bands, clips and dust.
- Straighten the folds or corners of the banknotes before insertion.
- Put the banknotes on the hopper as shown below.

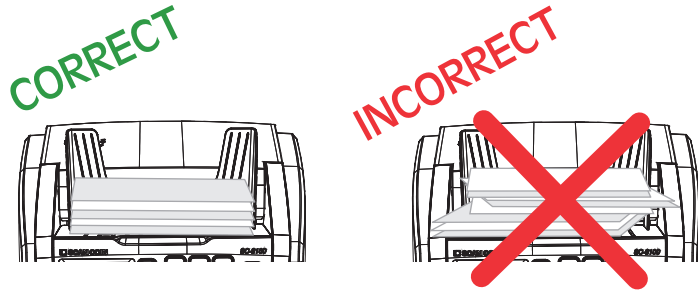

- Adjust the note guides according to the longest banknote in the stack.

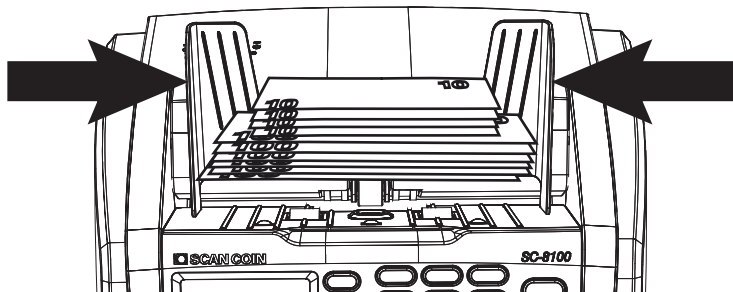

Functions

By default counting starts when the banknotes are placed on the hopper.

- To change the setup to start counting by pressing **START** see [“Auto Start On/Off” on page 10.](#)

Note!

Make changes only when there is no banknote on the hopper and in the stacker. However, the functions **DISP** and **PRNT** can be used when banknotes are in the machine.

Function	Description
DISP	DISP Select the type of display. Left and up navigation.
MODE	MODE Select a sorting mode. Sort modes are set in the Advanced setting menu see “Sort Mode” on page 14. Right and down navigation.
PRNT	PRNT Print a receipt. Confirm selections.
SET	SET Displays the SET menu in Currency mode and Detection Off mode.
2	Number keys Select menu items. Enter digits.
CUR	CUR Select between the installed Currency modes and the Detection Off mode.
C	C Clear the result. Delete the last input. Return to the previous menu.
START	START Start counting manually.

LCD Screen

The Main view of the screen displays the value and number of counted banknotes.

The List view displays the information as a list with information on value, quantity and number of counted banknotes.

- Press **DISP** to toggle between the two views.

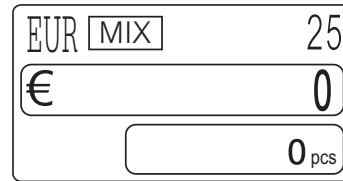

Print a Receipt

- a) Connect a thermal printer to the printer port. See [“Rear view” on page 4.](#)
- b) Press **PRNT**.
The receipt is printed.

Counting

- a) Press **CUR** to select a currency or deactivate the detection (**OFF**) - Detection Off mode.

Note!

The function of **CUR** is only available in the Main view.

- b) Press **MODE** to select a sorting mode.

The sorting modes available depends on the settings done in the Advanced Setting see [“Sort Mode” on page 14.](#)

- c) Start counting.

Note!

Currency and value icons are displayed when a currency is selected and detection is activated.

When Detection Off mode is selected only the quantity will be displayed.



Settings in the SET Menu

Note!

When Detection Off mode is selected press **DISP** to toggle between the first (P1) and second page (P2) of the **SET** menu, see [“Detection Off Mode” on page 10.](#)

Counting Speed

- a) Press **SET**.
Page 1 (P1) of the SET menu is displayed.
- b) Press **2** several times to toggle between the three counting speeds **Low, Medium and High.**
- c) Press **SET** to exit.

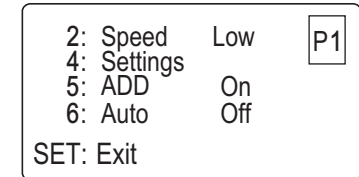

Settings

For information about the menu option Settings see [“Adjustments” on page 11.](#)

Add

When Add is activated the counting results of different bundles are accumulated automatically.

- a) Press **SET**.
- b) Press **5** to set Add **On** or **Off**.
- c) Press **SET** to exit.

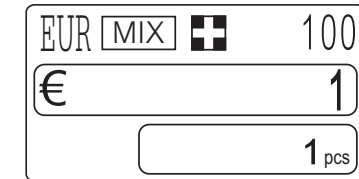

The Add icon  is displayed when Add is activated.

Auto Start On/Off

Activate Auto Start to start counting when the banknotes are placed on the hopper.

- Press **SET**.
- Press **6** to turn on or off Auto Start.
- Press **SET** to exit.

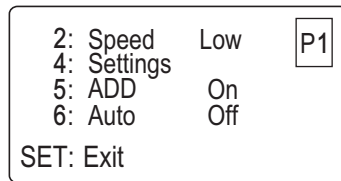

Detection Off Mode



When the detection is deactivated the UV, Size and MG detections can be activated if needed. Settings can be done in the Main view or via the SET menu.

In the Main view:

Press **DISP** or **PRNT** to activate UV and MG respectively.

In the SET menu:

- Press **SET**.
Page 2 (P2) of the SET menu is displayed.
- Press **7**, **8** or **9** to activate UV, Size and MG respectively.
OFF - the detection is deactivated.
- Press **SET** to exit.

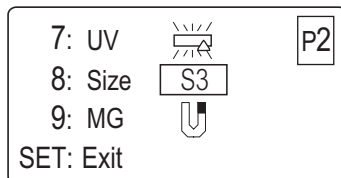
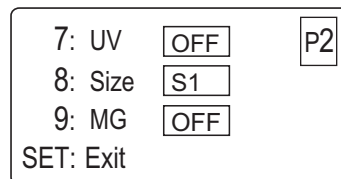

Note!

Press **DISP** to go to the first page (P1) of the **SET** menu.

UV detection

Press **7/DISP** to select one of the two UV detections.

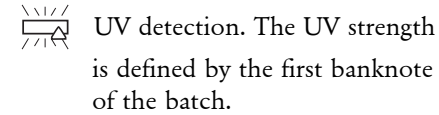

Size detection

- Press **SET**
- Press **8** several times to toggle between the different levels of Size detection.

There are level **S1** to level **S7** to select between. Level **S7** is the most strict size detection level. Default setting is **S3**.

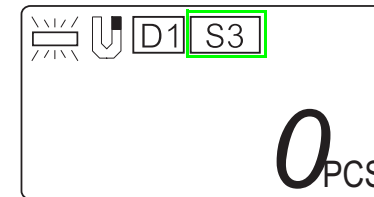

MG detection

Press **9/PRNT** to activate the magnetic detection.

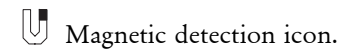

Double detection

Press **MODE** to toggle between the different levels D1 to D5.

Default setting is D2.

Level D5 is the strictest.



Batch Counting

Count a preset number of banknotes from 1 to 999.

In the counting screen:

- Press **0-9** to enter the desired quantity.

The preset batch is displayed in the upper right corner of the screen.

- Start counting.



To clear the batch:

- Press **START**.
- Press **0**.
- Press **START** to confirm.

To cancel the batch and revert to the previous setting:

- Press **C**.

Adjustments

In the Settings menu different adjustments can be done.

- Press **SET**.
- Press **4** to enter the Settings menu.
- To navigate in the menus use **DISP** (← left or ↑ up), **MODE** (→ right or ↓ down) and **PRNT** (confirm).

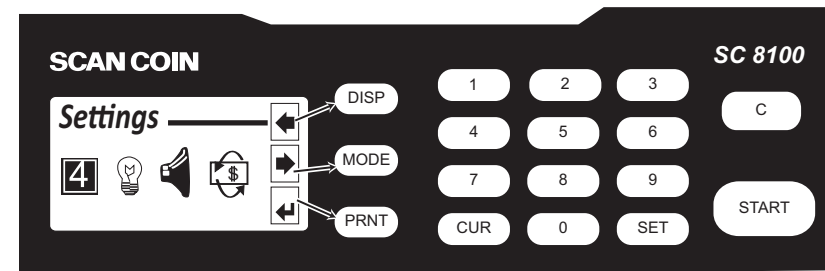
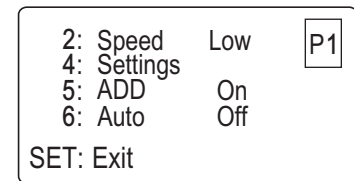

Contrast

Adjust the contrast of the LCD screen from level 1 (light) to level 7 (dark).

- Highlight the **Contrast** icon.
- Press **PRNT**.
- Adjust the contrast up or down with **DISP** or **MODE**.
- Press **PRNT** to confirm and return to the Settings menu.



Press **C** to revert to the previous setting and return to the Settings menu.

- Press **C** to return to the Main view.



Back Light

- Highlight the **Back Light** icon
- Press **PRNT**.
- Set the back light on or off with **DISP** or **MODE**.
- Press **PRNT** to confirm and return to the Settings menu.
Press **C** to revert to the previous setting and return to the Settings menu.
- Press **C** to return to the Main view.

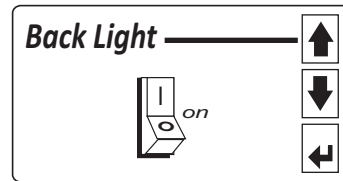

Sounds

- Highlight the **Sounds** icon
- Press **PRNT**.

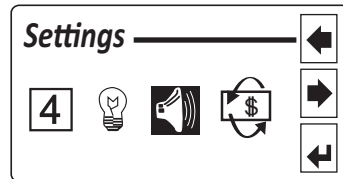

Alarm

Alarm gives a warning when a suspicious banknote is detected.

- Highlight **Alarm**.
- Press **PRNT**.
- Use up (**DISP**) or down (**MODE**) in the list and make a selection.

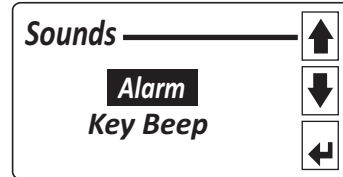

Alarm Off - warning is turned off.

Suspicious - alarm is turned on and gives a warning when there is a suspicious banknotes.

Alarm On - alarm is turned on and gives a warning when any notice occurs.

- Press **PRNT** to confirm and return to the Sounds menu.



Press **C** to revert to the previous setting and return to the Sounds menu.

- Press **C** to return to the Settings menu.
- Press **C** once again to return to the Main view.

Key Beep

- Highlight **Key Beep**.
- Press **PRNT**.
- Set the back light on or off with **DISP** or **MODE**.
- Press **PRNT** to confirm.
Press **C** to revert to the previous setting.
- Press **C** to return to the Settings menu.
- Press **C** once again to return to the Main view.

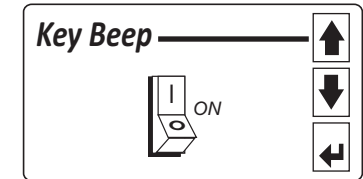
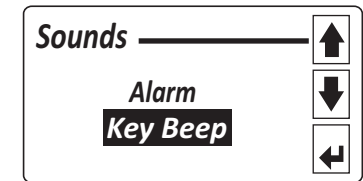

Exchange Table

It is possible to set an exchange rate in a local currency for a foreign currency. The result is only shown on the printed receipt (see ["Print a Receipt" on page 9](#)).

- Highlight the **Exchange Table** icon.
- Press **PRNT**.
- Press **MODE** to highlight the currency for which a currency will be set.
- Press **0-9** to insert the current rate (up to six digits).
Press **PRNT** for the decimal separator.
Press **DISP** to delete the last digit.
- Press **START** to return to the Settings menu.
- Press **C** to return to the Main view.

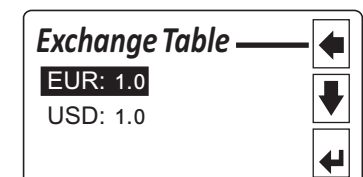

Advanced Setting

In the Advanced Setting there are several different setups.

- Highlight the **Advanced Setting** icon.
- Press **PRNT**
- To navigate in the menus use **DISP** (↑up), **MODE** (↓down) and **PRNT** (confirm).
- Press **C** to return to the Settings menu.
- Press **C** once again to return to the Main view.

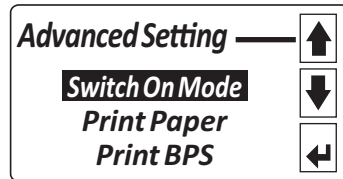

Switch On mode

Configure a preferable restart up.

- Highlight **Switch On Mode**.
- Press **PRNT**.
- Select the desired mode.
Default - starting up the machine with factory default settings.
Turn off Status - starting up the machine with the last settings.
- Press **PRNT** to confirm.
Press **C** to revert to the previous setting.
- Press **C** to return to the Settings menu.

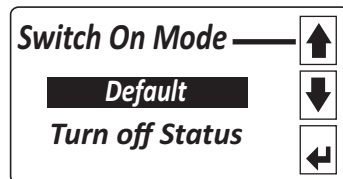
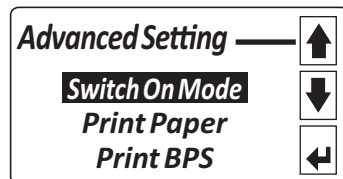

Print Paper

Setup the paper size of the connected thermal printer.

- Highlight **Print Paper**.
- Press **PRNT**.
- Select the paper size.
W57.5: 2 inches paper.
W79.5: 3 inches paper (default).
- Press **PRNT** to confirm.
Press **C** to revert to the previous setting.
- Press **C** to return to the Settings menu.

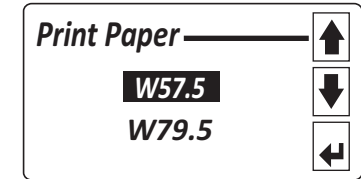
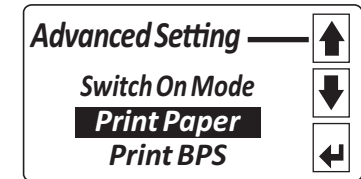

Print BPS

Setup the baud rate for printing out receipts.

- Highlight **Print BPS**.
- Press **PRNT**.
- Select the baud rate.
9600: 9 600 bps.
38400: 38 400 bps.
115200: 115 200 bps (default).
- Press **PRNT** to confirm.
Press **C** to revert to the previous setting.
- Press **C** to return to the Settings menu.

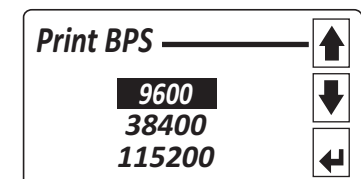
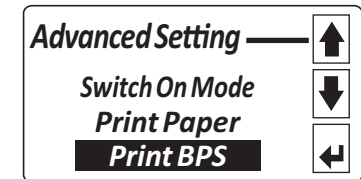

Stacker Full Quantity

Setup the maximum capacity of banknotes.

- Highlight **Stacker Full Qty**.
- Press **PRNT**.
- Select the desired maximum capacity.

50: 50 pcs
100: 100 pcs
150: 150 pcs
200: 200 pcs (default)

- Press **PRNT** to confirm.
 Press **C** to revert to the previous setting.
- Press **C** to return to the Settings menu.

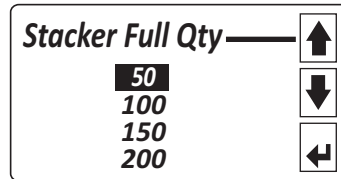
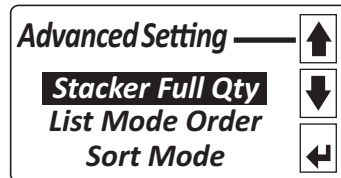

List Mode Order

Setup the sort order of the list when the LCD screen is in List Mode see [“LCD Screen” on page 5](#).

- Highlight **List Mode Order**.
- Press **PRNT**.
- Select the desired sort order **Small to Large** (default) or **Large to Small**.

- Press **PRNT** to confirm.
 Press **C** to revert to the previous setting.
- Press **C** to return to the Settings menu.

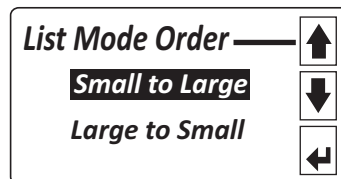
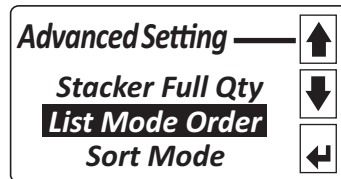

Sort Mode

Setup the sorting mode. (Default sorting mode is DD.)

- Highlight **Sort Mode**.
- Press **PRNT**.
- Use: **DISP** (↑ up), or **MODE** (↓ down) to select a row
- Press **4** or **6** to make a selection in the current row.

DD

Banknotes are counted with the denomination of the first detected genuine banknote. Counting stops when a different value or suspicious banknote is detected.

Sort

Banknotes are counted with the denomination of the first detected genuine banknote. Counting stops when a different value or suspicious banknote is detected. The counting is then continued with the denomination of the second detected genuine banknote.

Face

Banknotes are counted with the face of the first detected genuine banknote. Counting stops when a different face or suspicious banknote is detected.

Ornt

Banknotes are counted with the orientation of the first detected genuine banknote. Counting stops when a different orientation or suspicious banknote is detected.

Emisn

Banknotes are counted with the emission of the first detected genuine banknote. Counting stops when a different emission or suspicious banknote is detected.

- Press **PRNT** to confirm.
 Press **C** to revert to the previous setting.
- Press **C** to return to the Settings menu.

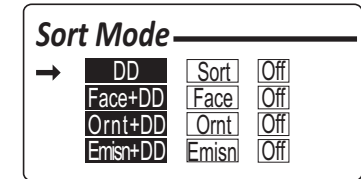
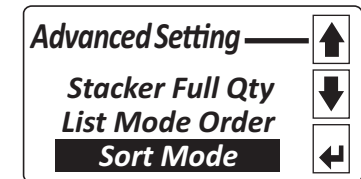

Batch Add Mode

When Batch Add Mode is activated the current sum of banknotes are added to the total counting.

- Highlight **Batch Add Mode**.
- Press **PRNT**.
- Set Batch Add Mode on or off with **DISP** or **MODE**.
- Press **PRNT** to confirm.
Press **C** to revert to the previous setting.
- Press **C** to return to the Settings menu.

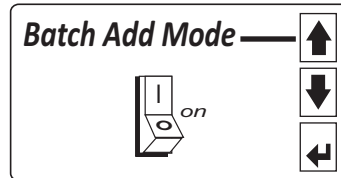

Device Information

To retrieve the currency version and machine detail information.

- Highlight the **Device Information** icon.
- Press **PRNT**.
The first page displays the currency version.
- Press **DISP** or **MODE** to go to the second page which displays machine detail information:
TN: machine type name
FV: firmware version
MD: production date
SN: serial number
CN: total count
- Press **C** to return to the Settings menu.

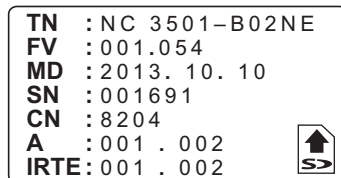
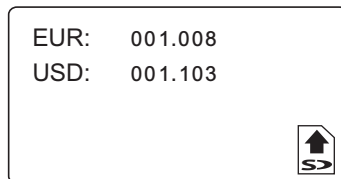

Thickness Setting

Thickness setting must always be adjusted to achieve a proper and smooth feeding of banknotes/documents. The thickness is adjusted with the thickness adjustment knob found on the top of the machine, see [“Rear view” on page 4](#).

- If the machine stops frequently and displays **Error-Double Sheet**:
Turn the adjustment knob slightly counter-clockwise to decrease the gap between the feed rollers.
- If the banknotes run too hard or too slow:
Turn the adjustment knob clockwise to increase the gap between the feed rollers.



Troubleshooting

If a fault remains or reoccurs, contact your SUZOHAPP representative.

Error Message	Description/Action
Error-Dimension	Odd sized banknote/document detected. Check and remove the banknote.
Error-Denomination	Wrong denomination detected in DD mode.
Error-Double Sheet	Double fed banknotes/documents detected. Check and recount all banknotes/documents. Adjust the thickness, see “Thickness Setting” on page 15.
Error Emission	Wrong emission detected in emission sorting mode.
Error-Paper Jam	A banknote/document is stuck inside the machine. Open up and clear the jammed banknote/document. Make sure no pieces remain
Error Image	Image of banknote not found in database. Can be caused by dirty or damaged banknotes.
Error Ornt	Incorrect orientation detected in orientation sorting mode.
Error-SlantNote	Skew fed banknote/document. If the problem reoccurs - check thickness adjustment and/or check for dirt in the machine. See “Thickness Setting” on page 15 and “Cleaning” on page 17.
Error-Timeout	Speed too high when connected to PC Suite. Reduce speed to Medium.
Error Wrong Face	Incorrect face detected in face sorting. Remove the banknote.
Unknown document	Unknown document detected in the stacker. Remove the document.

Reject Reason Message	Description/Action
Batch not completed	Final batch in bundle did not reach the set batch size.
Chain Error	Chain fed banknotes/documents detected. Check banknotes/documents and recount all banknotes/documents.
Check Bill Path	Problems detected in bill path. Open up the bill path and check all sensors for dirt and pieces of paper. Clean the sensors. See “Cleaning” on page 17.
Check Stacker	Check and remove all banknotes/documents from the stacker.
Check Hopper	Check and remove all banknotes/documents from the hopper.
Remove stacker notes	Banknotes/documents detected in stacker. Remove all banknotes/documents.
Stacker Full	The number of banknotes/documents in the stacker have reached the maximum set quantity. Change and set correct batch size.
SuspiciousNote-IR	Banknote with IR image not found, suspect banknote.
SuspiciousNote-MG	Banknote with MG image not found, suspect banknote.
SuspiciousNote-UV	Banknote with UV image not found, suspect banknote.
Wrong Ornt	Detected a banknote with the wrong orientation. Remove the banknote.

Maintenance

Cleaning

Clean the machine daily to prevent from accumulation of dirt, since this may cause too many banknotes to be rejected.

Use an air brush to blow away dirt from the sensors.

Caution!

Only use cleaning materials and tools which do not scratch.

- Clean the outside of the machine with a soft cotton towel.
- Open up the bill path with a firm drag with one hand.
- Clean the bill path with a brush or a soft cotton towel.



SD Update

- Press **SET**.
- Press **4** to enter the Settings menu.
- Highlight **Device Information**.
- Press **PRNT**.
- Insert the SD card in the SD card slot. See [“Rear view” on page 4](#).
- Press **PRNT**.
 - The upgrade starts.
 - Wait approximately 3 minutes.
 - Do not operate or turn off the machine.
 - When the upgrade is finished the screen will display **OK**.
- Reset the machine by switching it off and then on again.

The machine will start with the normal start screen.

Note!

If the upgrade does not work the screen will display **NG**. Do the upgrade one more time. If it still does not work contact your SCAN COIN representative.

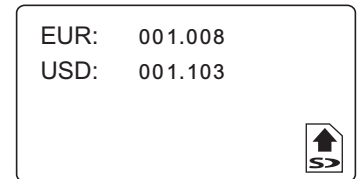
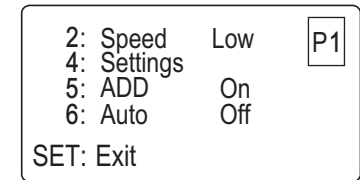

Please wait for upgrading

Upgrading

Please reset machine

OK

Sd Upgrade

NG

Technical Data

Part number:

SC-8100810010-XXX

Supply voltage/frequency. 100–240 V AC, 60/50 Hz

Current consumption. 0.350–0.175 A

Fuse 5 AT

Power consumption:

Max. 40 W

SD card:

TypeSDHC

Class 4, 6, 8, 10.

Capacity4G ~ 32G

Format..... FAT32

Speed:

Currency mode

Low600 notes/min

Medium800 notes/min

High..... 1 000 notes/min

Detection off mode

Low600 notes/min

Medium900 notes/min

High..... 1 500 notes/min

Capacity:

Hopper500 notes

Stacker pocket200 notes

Note size:

Width 60–100 mm (2.36–3.94")

Length..... 85–190 mm (3.35–7.48")

Dimensions:

Width 285 mm (11.22")

Depth 270 mm (10.63")

Height 280 mm (11.02")

Weight approx. 7.2 kg (22 lb)



EMA Headquarters

Antonie van Leeuwenhoekstraat 9
3261LT Oud-Bijerland The Netherlands

P +31 (0) 186 643333

F +31 (0) 186 643322

info.nl@suzohapp.com

NCS Headquarters

1743 Linneman Rd
Mount Prospect IL 60056 USA

P +1 (847) 593 6130

F +1 (800) 593 4277

info@suzohapp.com

APA Headquarters

44-48 Rocco Drive, Scoresby
Victoria Australia 3179

P +61 3 9757 5000

F +61 3 9763 7265

info@suzohapp.com.au

For more information:

SCAN COIN AB

Nordenskiöldsgatan 24
SE-211 19 Malmö, Sweden

P +46 (0) 40 600 06 00

info@scancoin.se